

Data Sheet

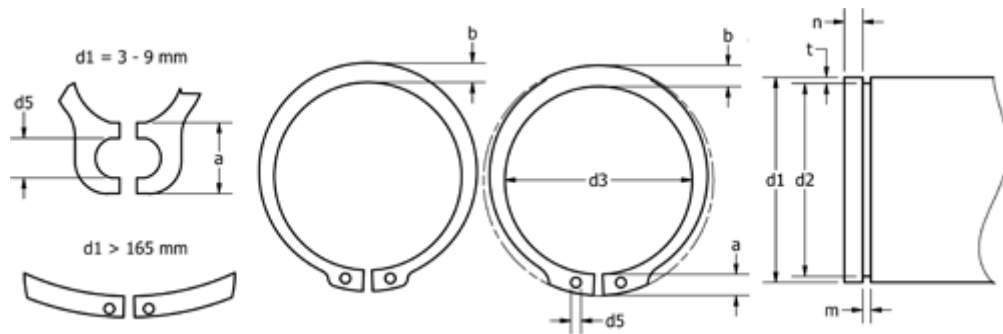

Article number: 0101098
 Description: Retaining ring A 100 DIN 471
 Spring steel
 Note: Fitted with ZGA pilers

Measures



a max	= 9.6	FN kN	= 90.0	s	= 3.00
AN mm ²	= 540.0	FRg kN	= 29.00	t	= 1.75
b	= 9.0	FR kN	= 206.00	tol	= -0.35
d1	= 100	g	= 3.5	tol	= -0.08
d2	= 96.5	K kN-mm	= 397.00	tol	= +0,54-1,30
d3	= 94.5	m min	= 3.15	Tong	= ZGA-4
d5 min	= 3.5	n abl x 1000	= 4.0	Weight kg/1000	= 53.700
Description	= A100	Nominal drive	= 5.3		